

LV699-386

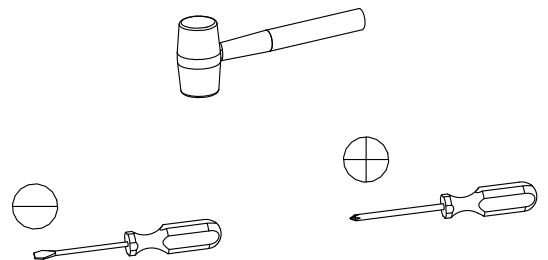
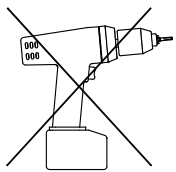
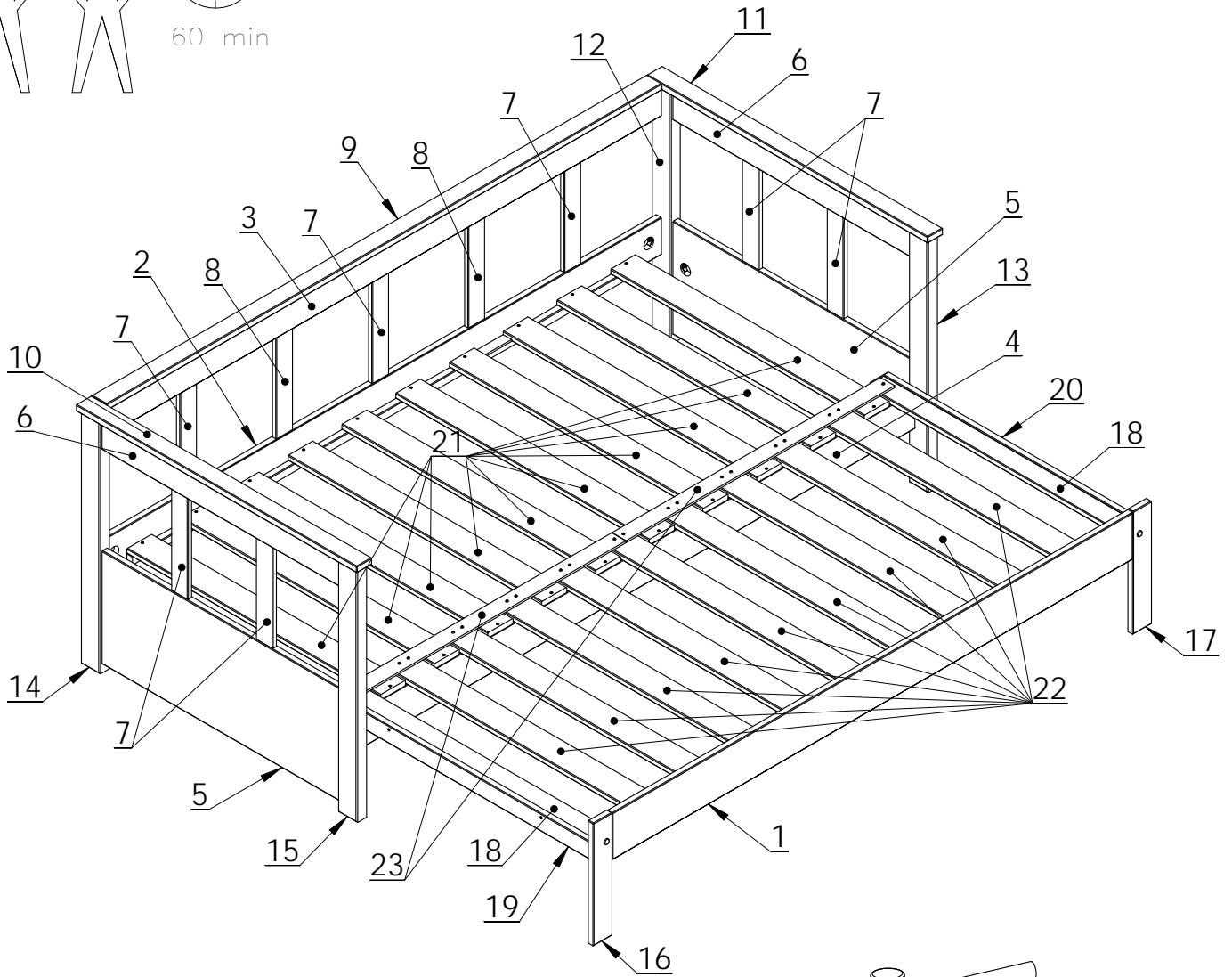
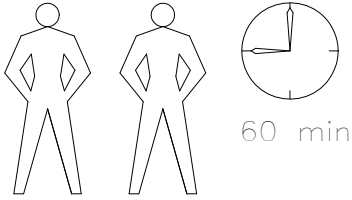

A		8x40	x96
B		7x60	x10
C		D35	x10
D		M6x55	x2
E		M6x10x13	x2
F		6,1x24x35	x8
G		D12x10	x8

H		5x50	x4
K		4x20	x24
M		3,5x35	x31
S		60x50x4	x2
T		102x30x6	x2
U			x1
V		4mm	x1

①

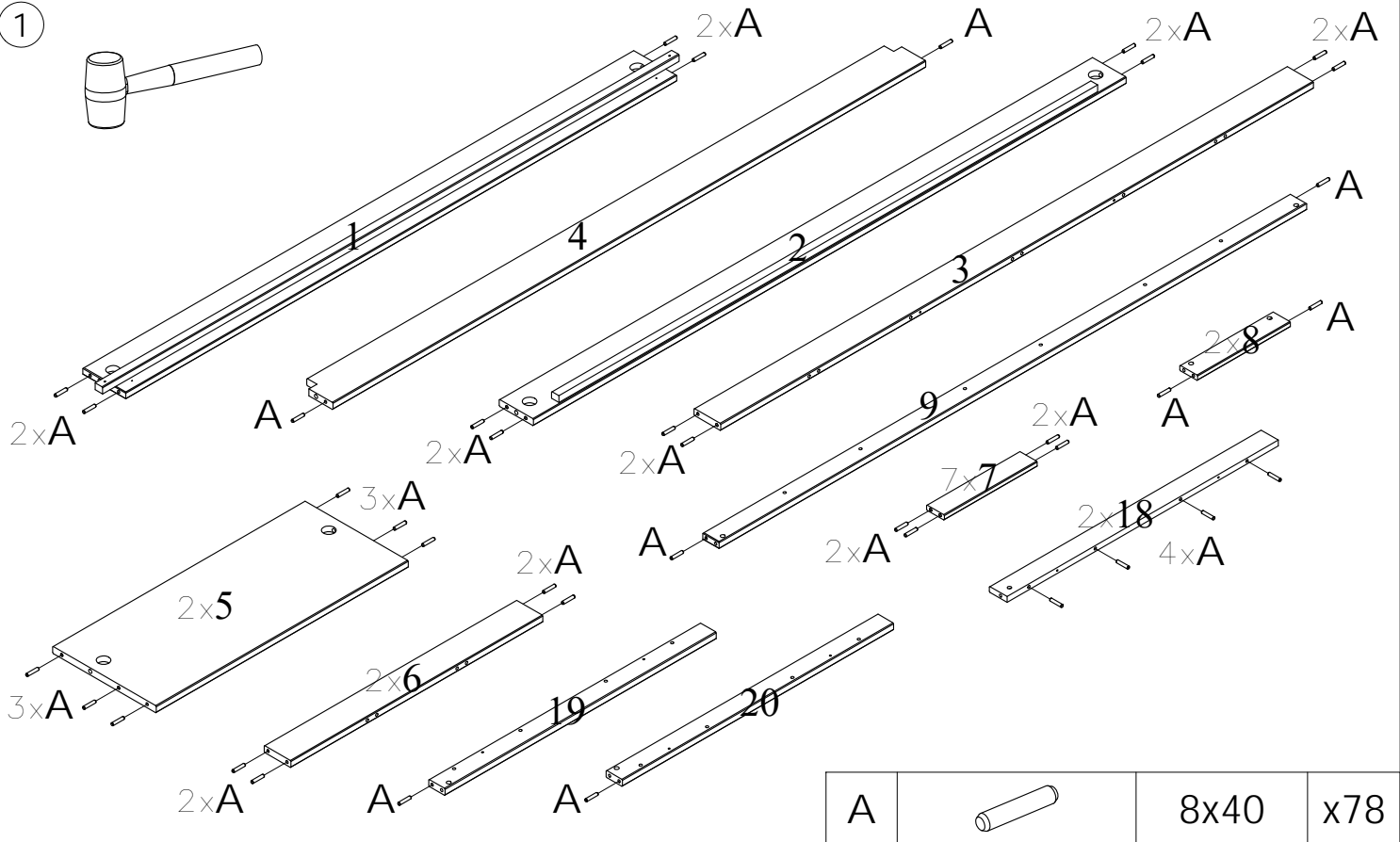

②

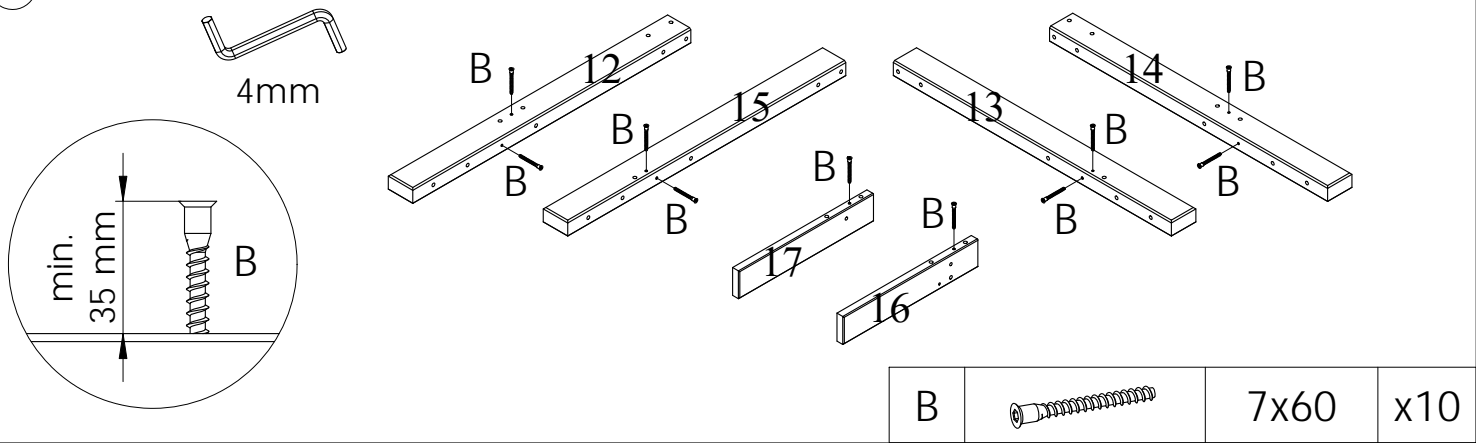

③

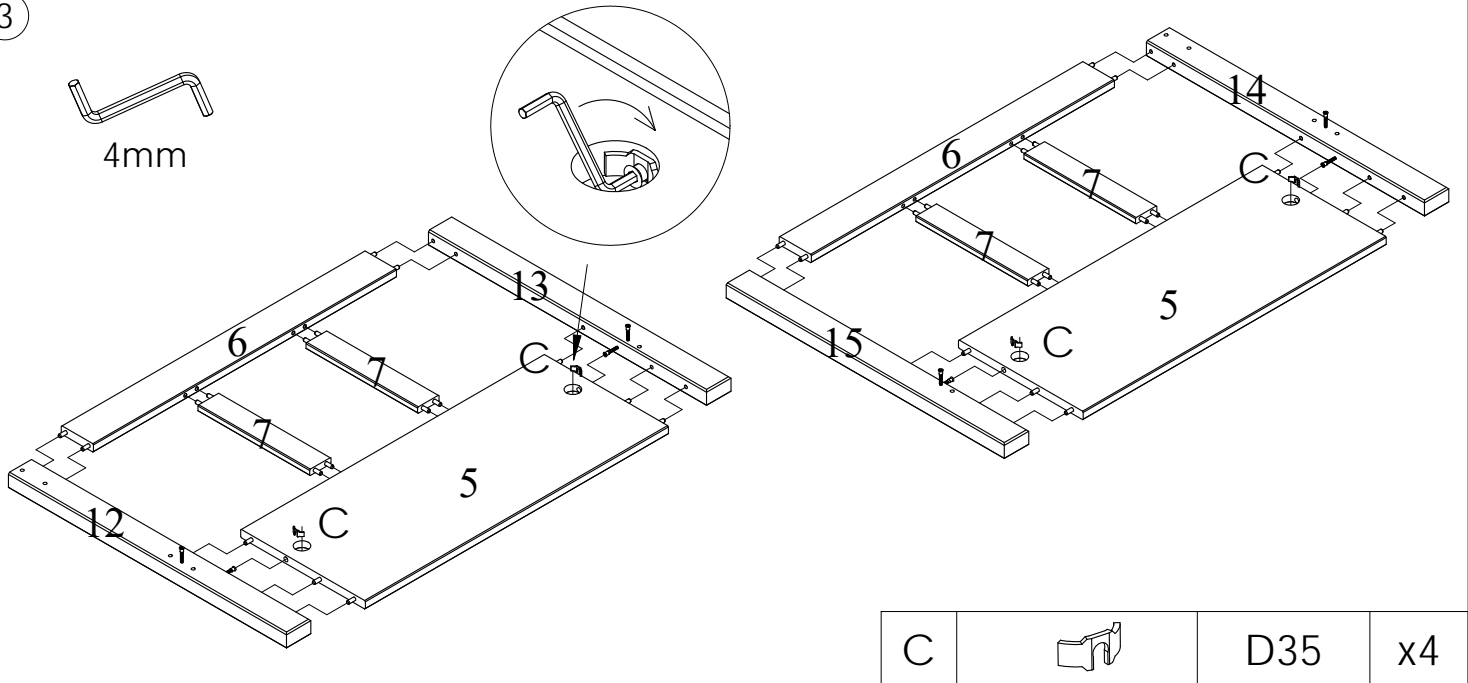

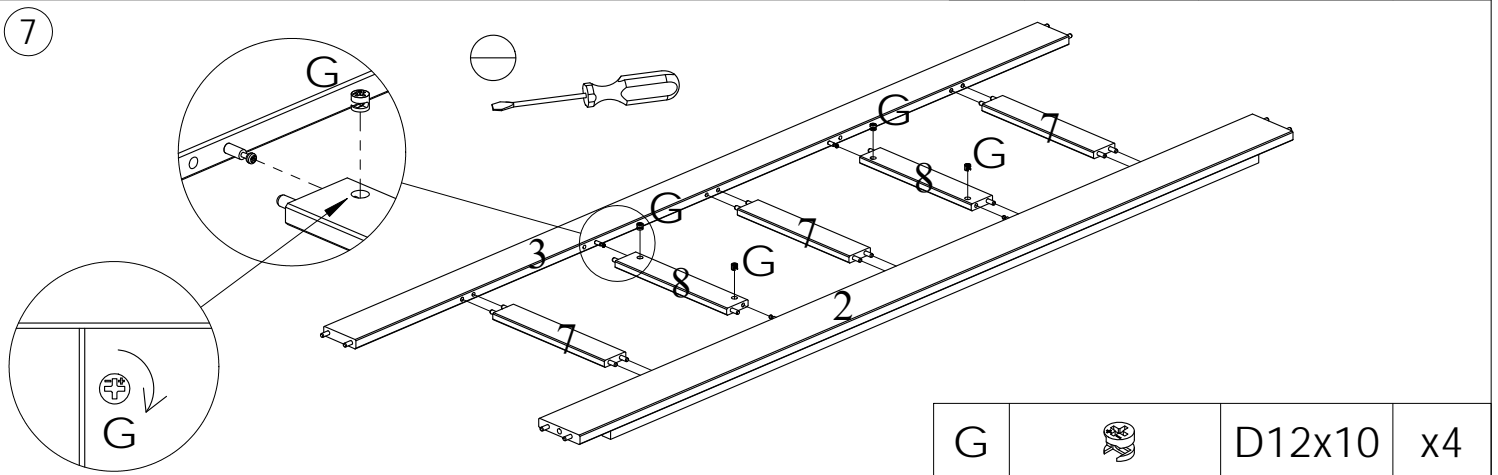
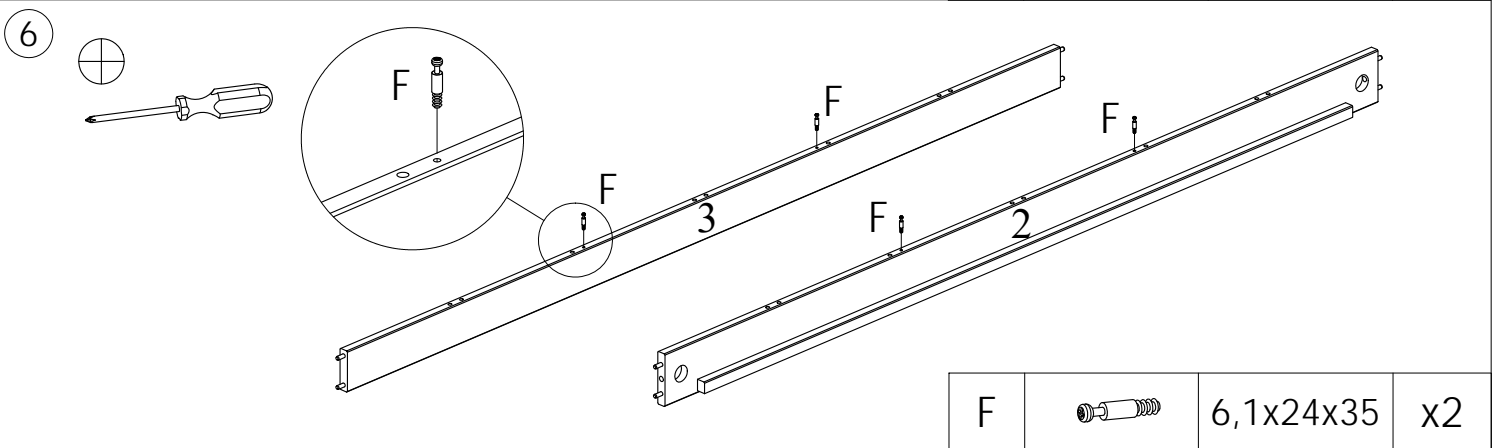
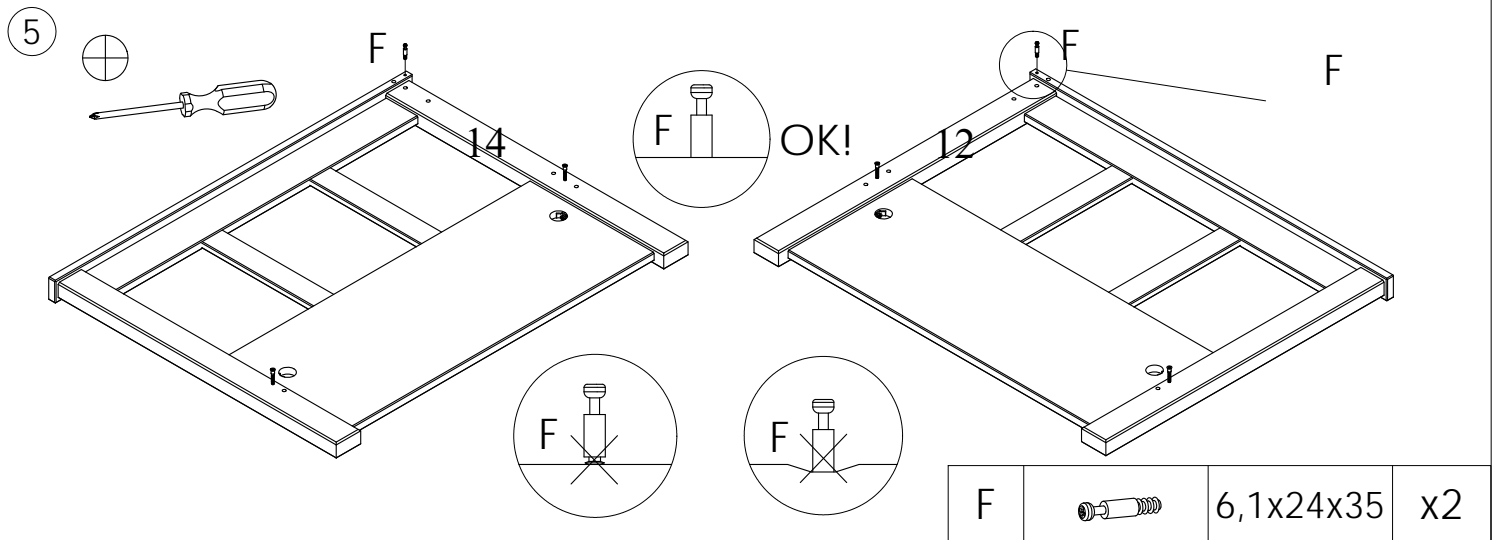
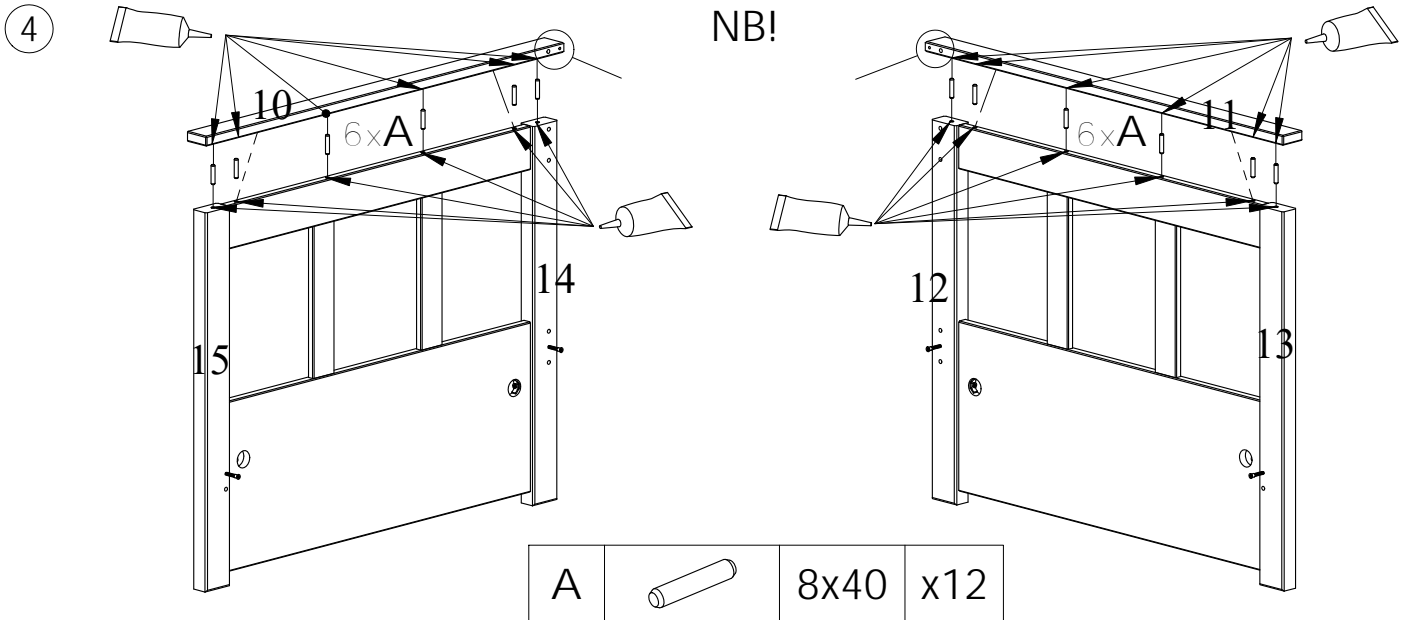

8

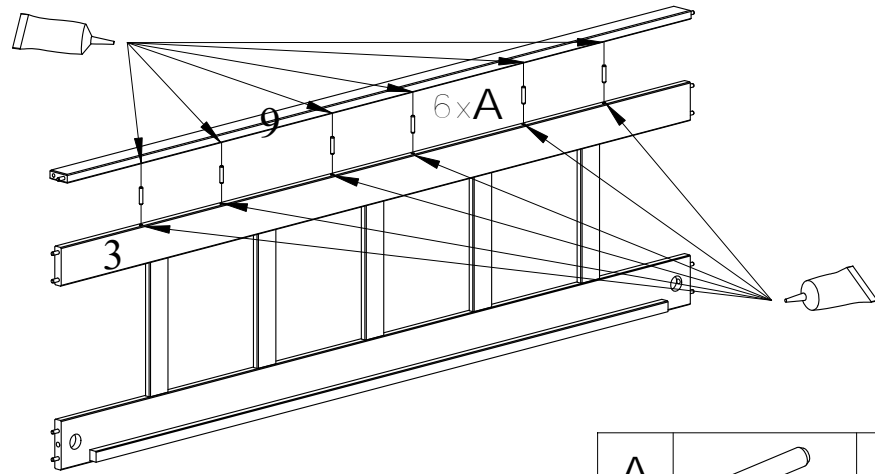

A		8x40	x6
---	---	------	----

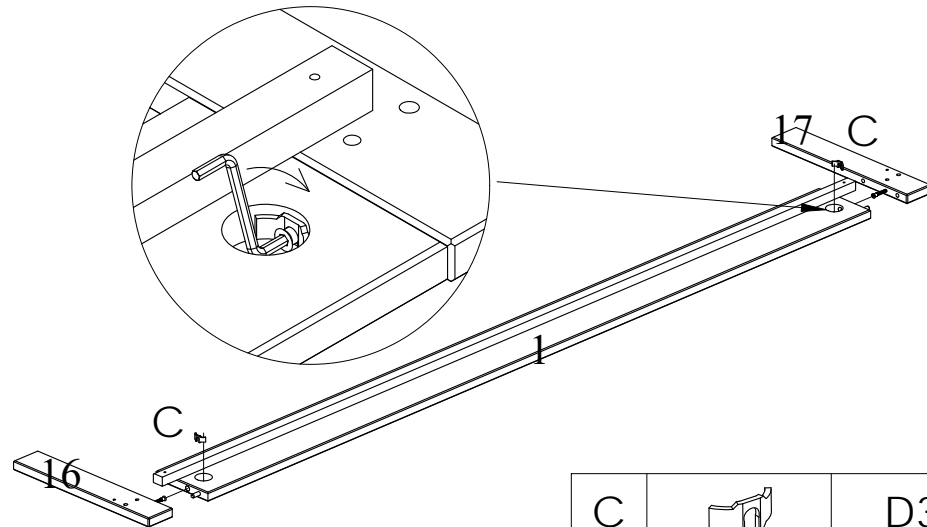
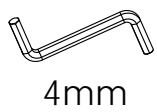

9

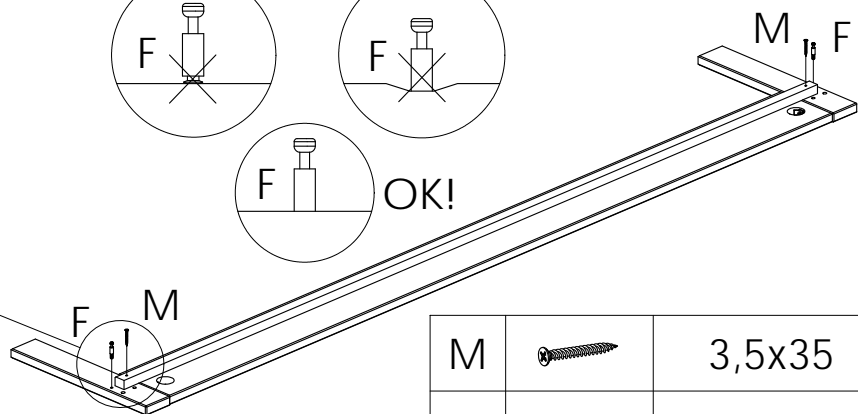
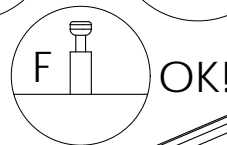
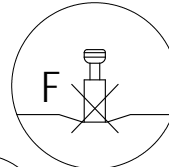
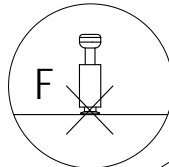
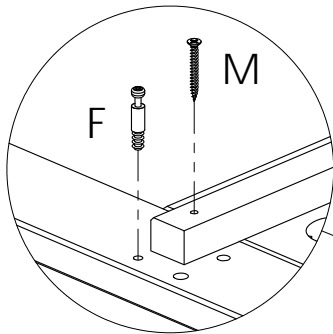
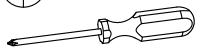

C		D35	x2
---	---	-----	----

10



M		3,5x35	x2
F		6,1x24x35	x2

11

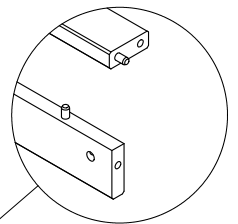
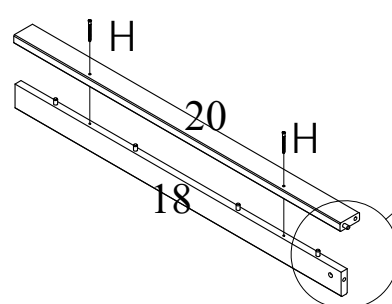
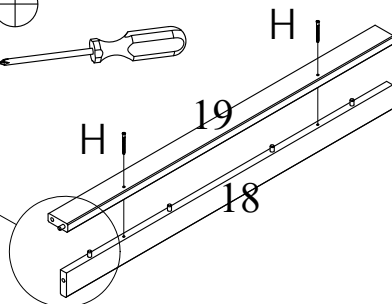
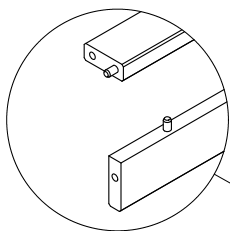
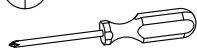

H		5x50	x4
---	---	------	----

12

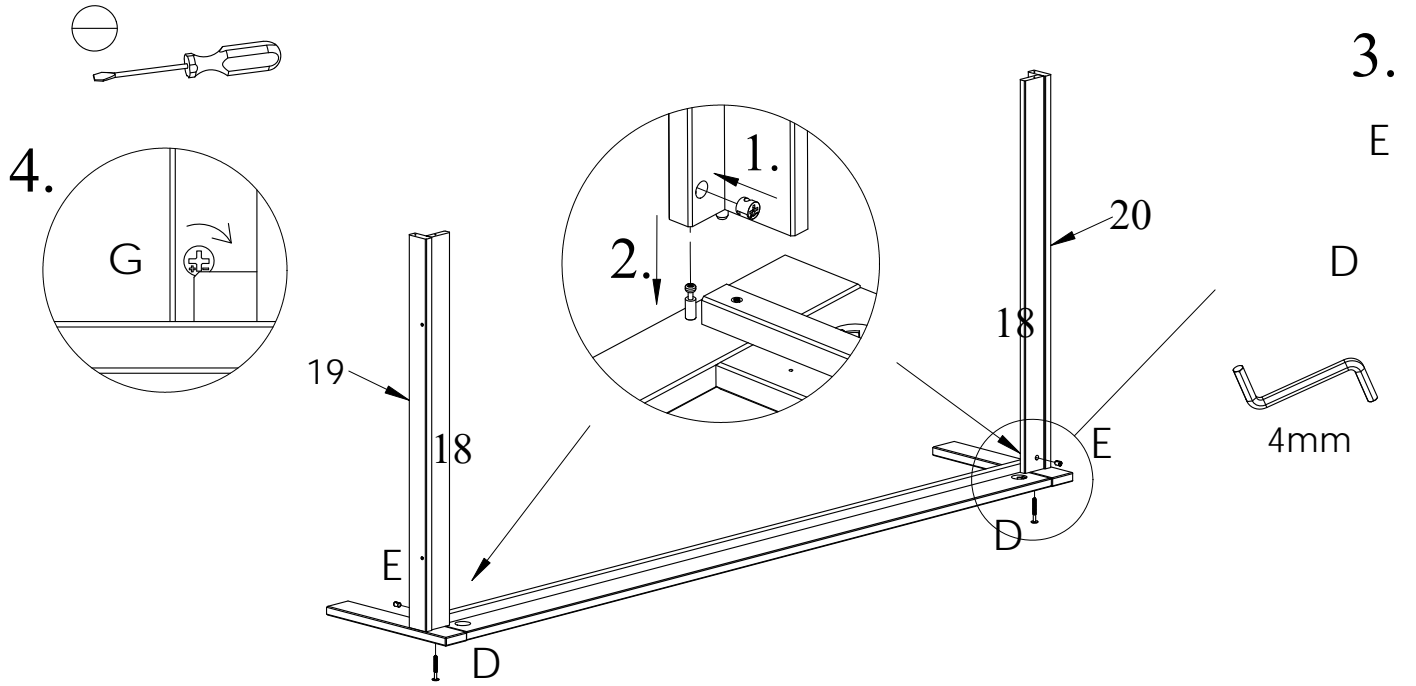



D		M6x55	x2
E		M6x10x13	x2

G		D12x10	x2
---	---	--------	----

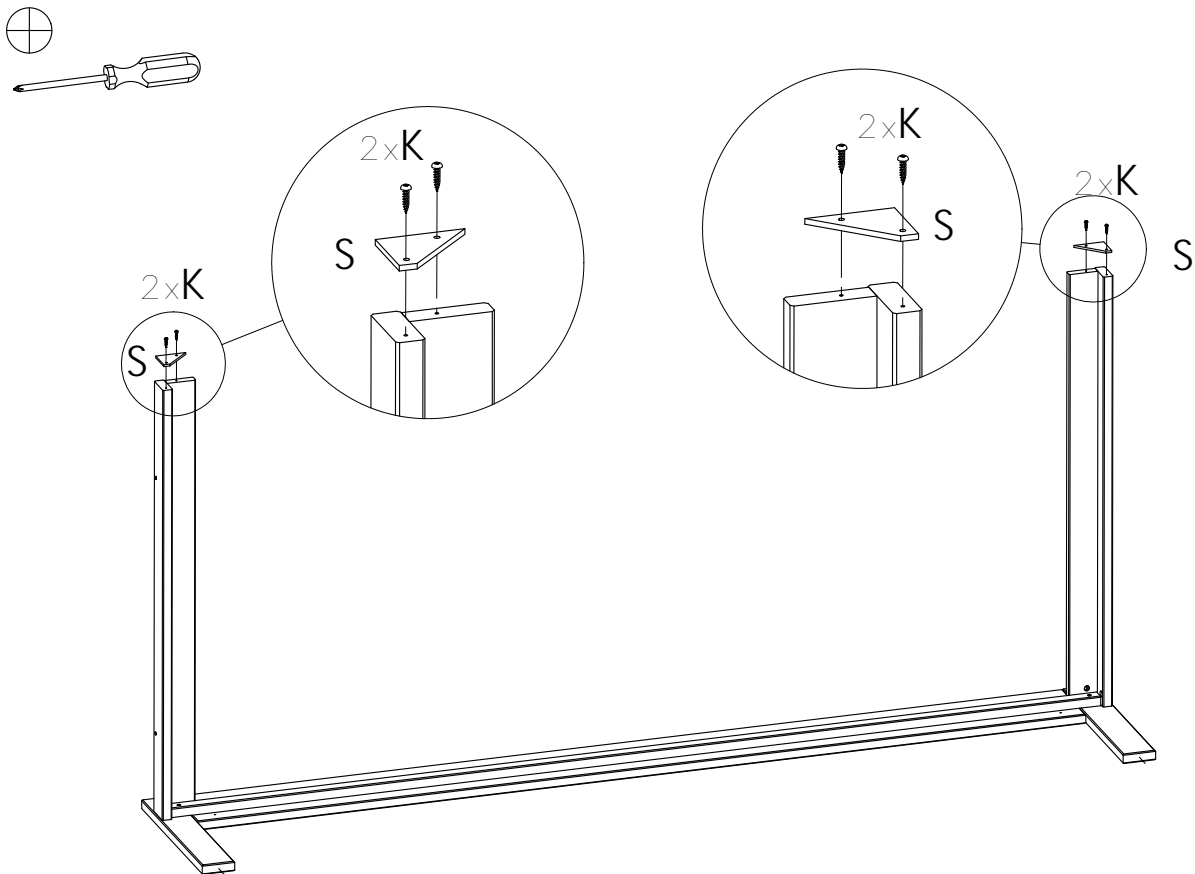
13



S		60x50x4	x2
K		4x20	x4

14

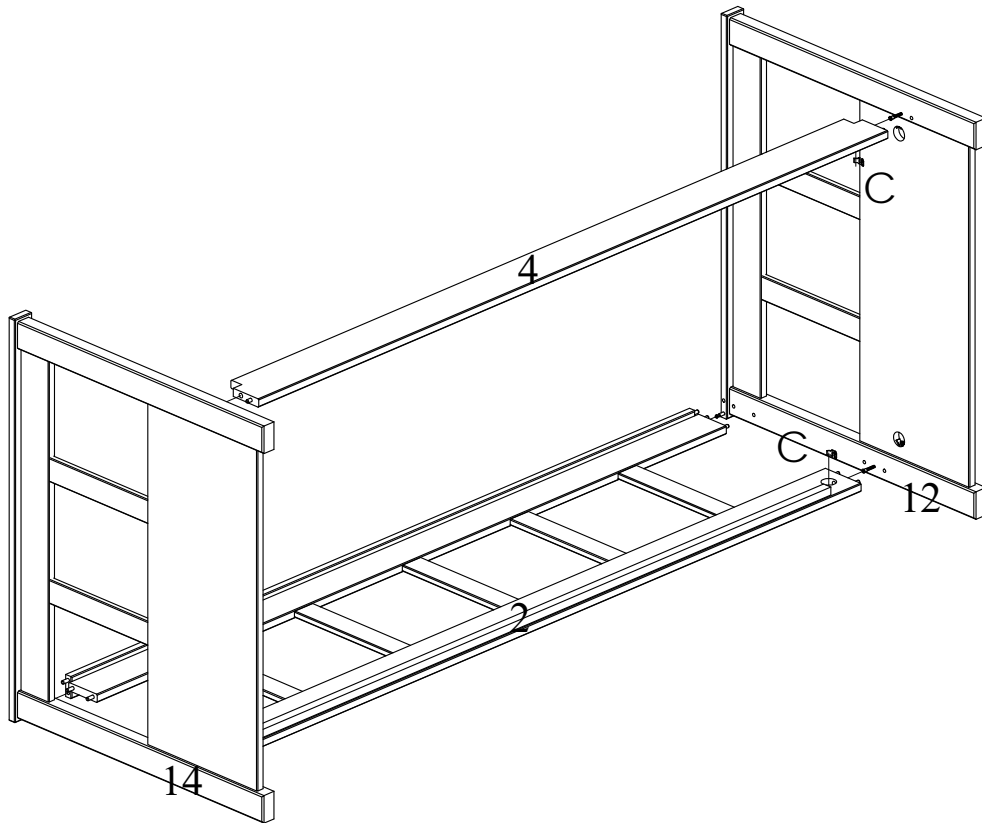
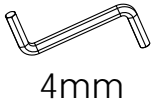

C		D35	x4
---	--	-----	----

15

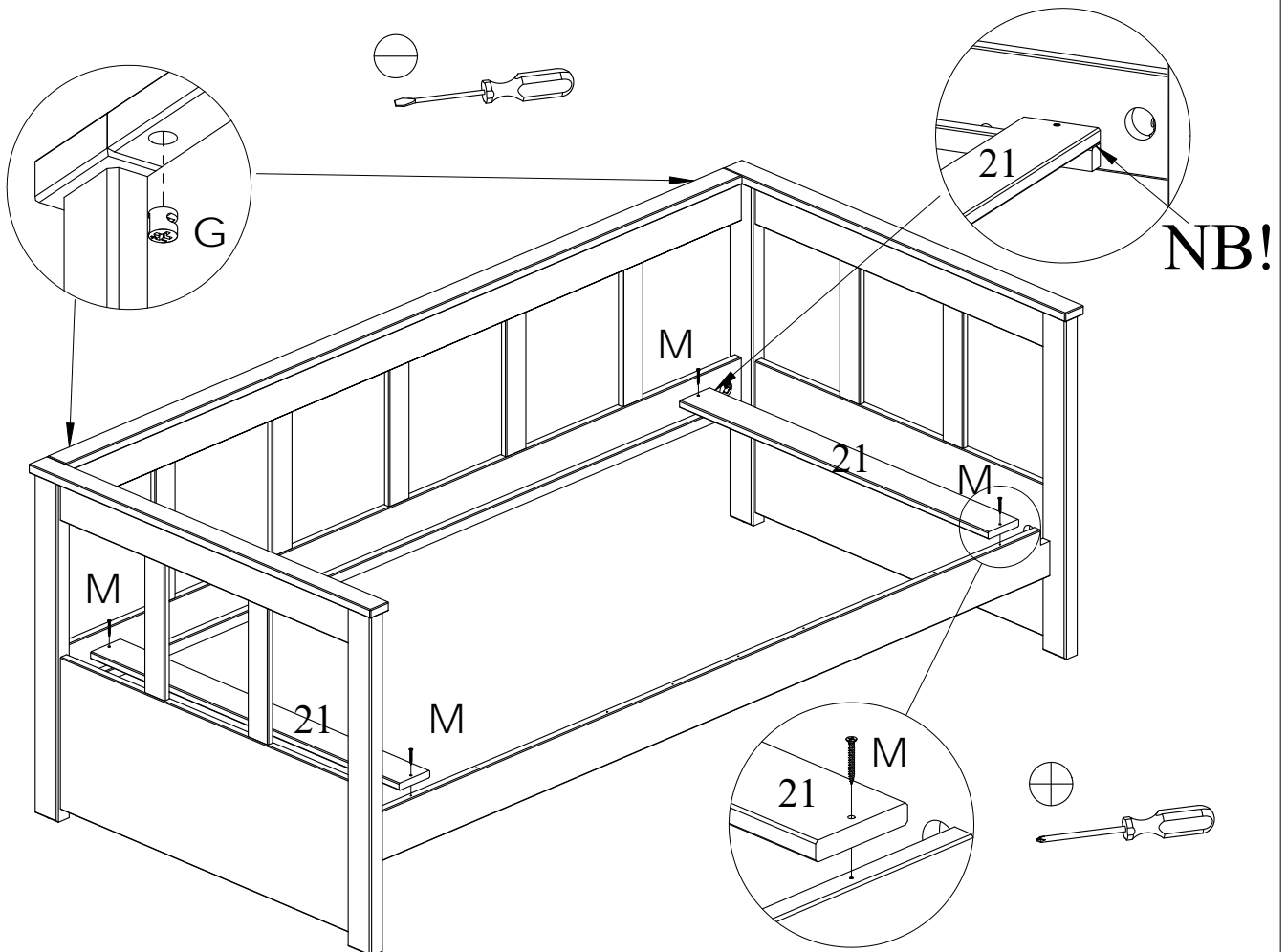

G		D12x10	x2
---	--	--------	----

M		3,5x40	x4
---	--	--------	----

16

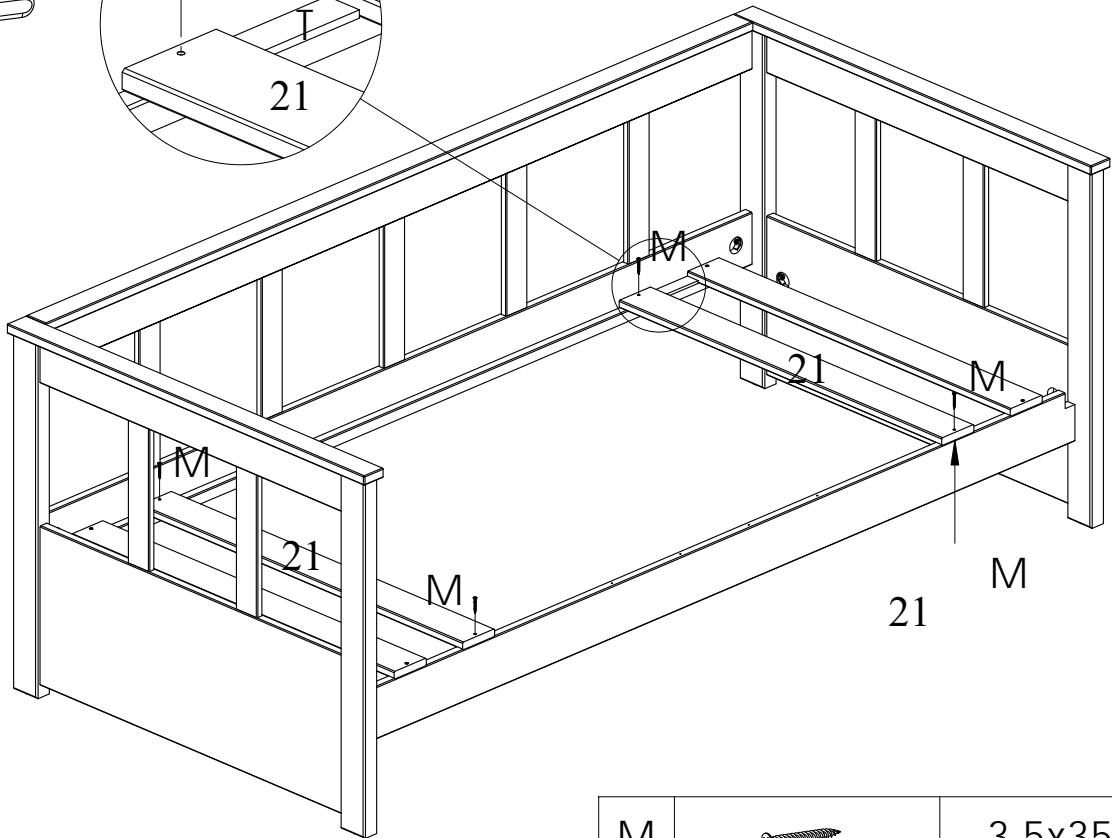
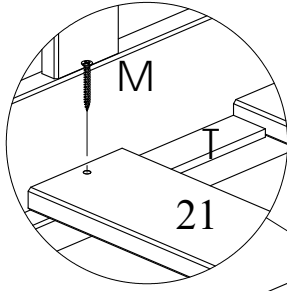
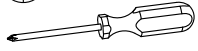

M		3,5x35	x4
T		102x30x6	x1

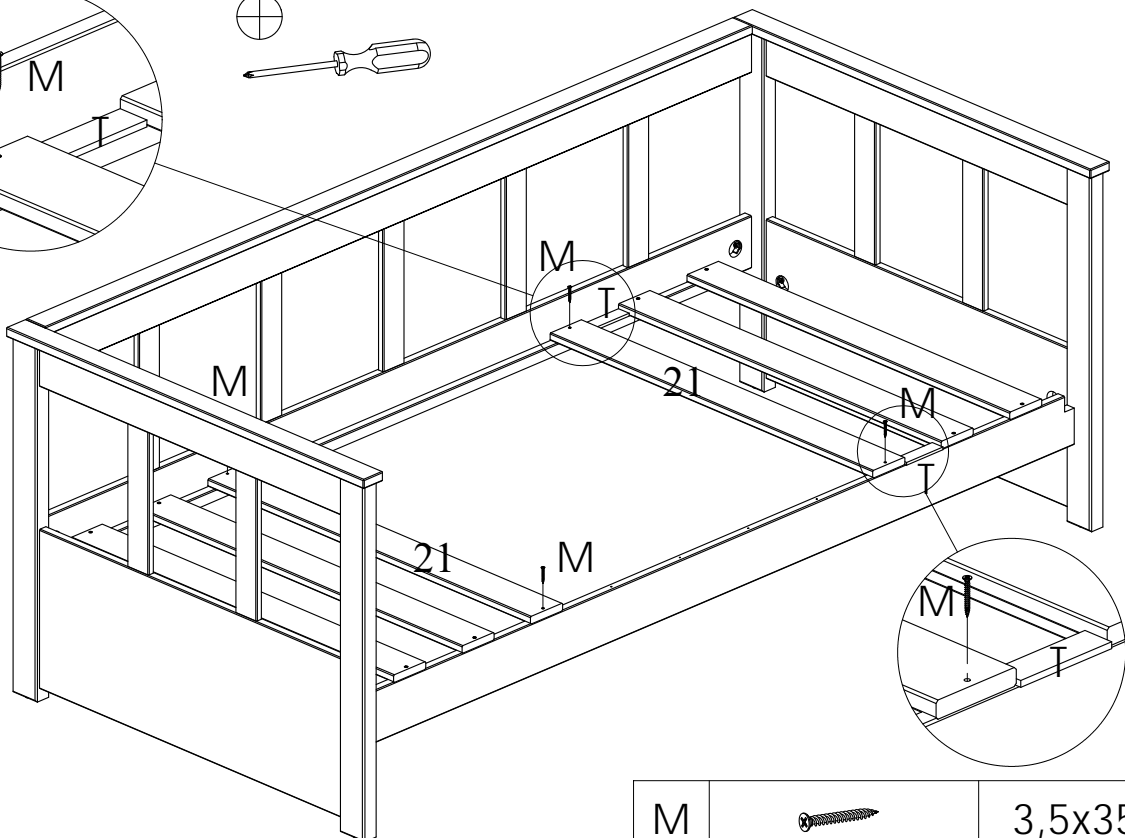
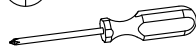
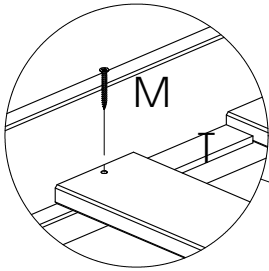

17



M		3,5x35	x4
T		102x30x6	x2

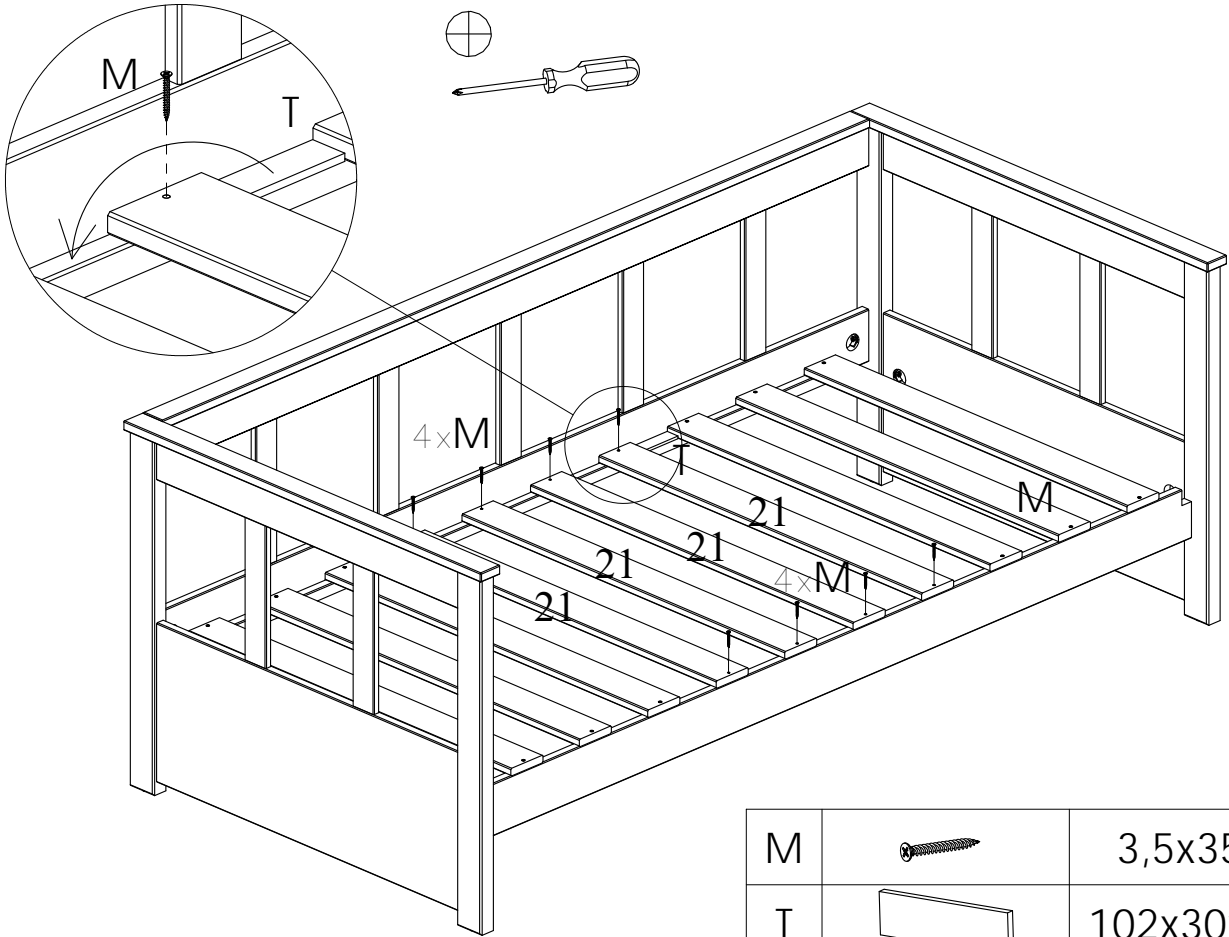

18

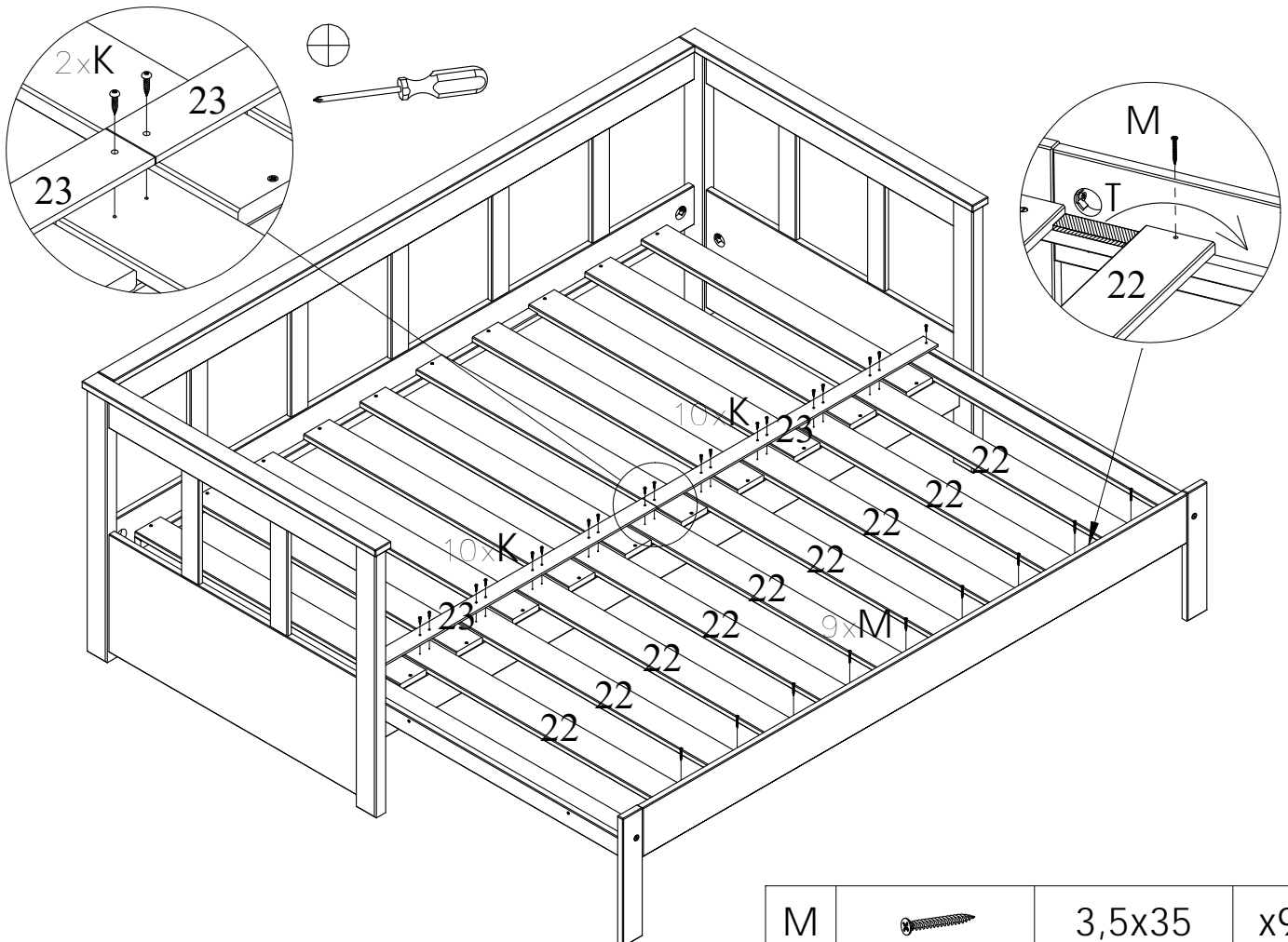

M		3,5x35	x8
T		102x30x6	x1

19



M		3,5x35	x9
T		102x30x6	x1

K		4x20	x20
---	---	------	-----