

Delphine

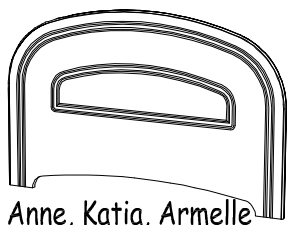

Anne, Katia, Armelle

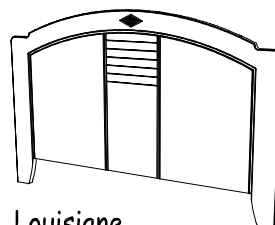

Louisiane



Louisiane dôme

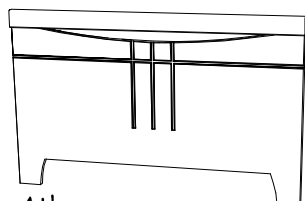

Athena crose

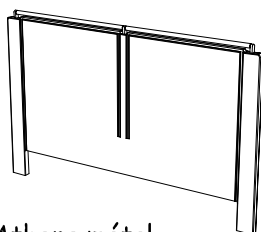

Athena métal

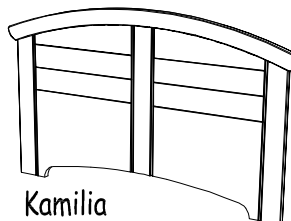

Kamilia Wallis

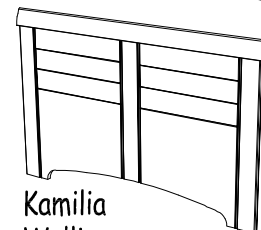

Kamilia Wallis

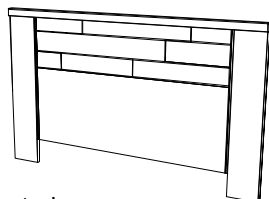

Lylou

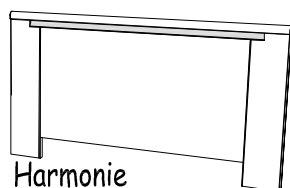

Harmonie Lesly crose

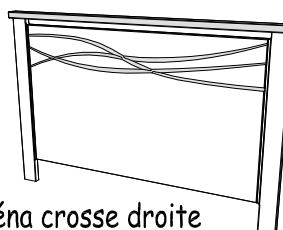

Séréna crose droite

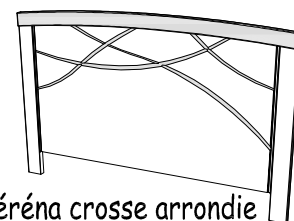

Séréna crose arrondie

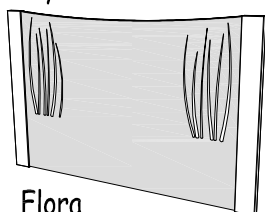

Flora

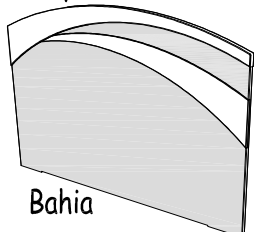

Bahia

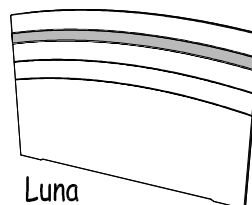

Luna

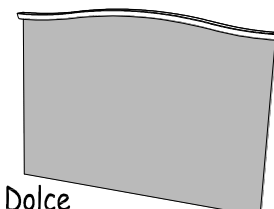

Dolce

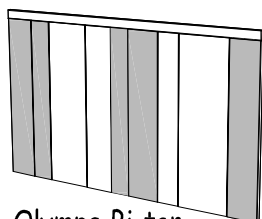

Olympe Bi-ton

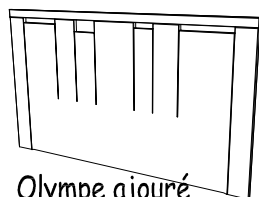

Olympe ajouré

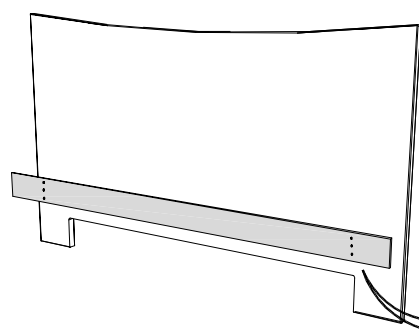

GABRIT DE POINTAGE

GAUGE

140 cm pour literie 140 - 160 - 180

WIDTH OF THE BASE

120 cm pour literie 120

90 cm pour literie 90

A Récupérer derrière la tête de lit
To be taken on the back of the headbord

40mm

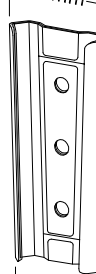

x2

45mm

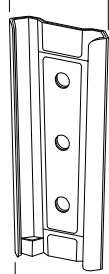

x2

4x16



x12



Edition : 680_2016-02

IMPORTANT

GARDEZ VOTRE NOTICE DE MONTAGE.
En cas de problèmes, elle sera le moyen le plus clair pour communiquer avec votre magasin.

IMPORTANT

KEEP YOUR ASSEMBLY INSTRUCTIONS.
In the event of a problem, it would be the easiest way to communicate with your retailer.

Conseil D'ENTRETIEN

Dépoussiérer avec un chiffon propre sec et doux. Pour les taches rebelles, passer une éponge humide et essuyer dans le sens du fil du bois avec un chiffon sec, propre et doux.
EVITER LES SOLVANTS, DILUANTS, ALCOOLS, ABRASIFS, PRODUIT SILICONE.

Cleaning INSTRUCTIONS

Wipe with a clean, dry and soft duster. For difficult stains, sponge out then dry in the wood grain by mean with a clean, dry and soft rag.
DO NOT USE SOLVANTS, ALCOHOL, ABRASIVES OR SILICONE.

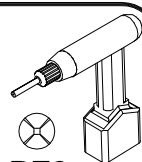
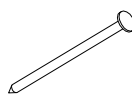
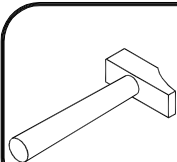

PZ2

1 MESURER LA HAUTEUR DU PIED DE VOTRE SOMMIER:
MEASURE THE FOOT'S HEIGHT OF YOUR BASE

2 POSITIONNER LE GABARIT SUIVANT **A** et **H**
POSITION THE GAUGE LIKE "A" and "H"

H=HAUTEUR PIED DU SOMMIER - 5mms
HEIGHT OF THE BASE'S FOOT - 5mms

EXEMPLE: PIED SOMMIER=100mms H=95mms
EXEMPLE: BASE'S FOOT=100mms H=95mms

"A" en mm		
pour Literie 90-120-140	pour Literie 160	pour Literie 180

DELPHINE	15	115	
ANNE	65	165	
ARMELLE	65	165	
KATIA	65	165	
LOUISIANE	83	183	283
LOUISIANE dôme	75	175	275
KAMILIA / WALLIS crosse droite	60	160	260
KAMILIA / WALLIS crosse arrondie	60	160	260
ATHENA crosse	60	160	260
ATHENA métal	60	160	260
LYLOU	110	210	210
HARMONIE / LESLY crosse	225	225	225
SERENA (crosse droite & arrondie)	86	186	286
FLORA	200	300	300
BAHIA	127	247	247
LUNA	150	250	250
OLYMPE bi-ton & ajouré	248	248	248
DOLCE	140	280	280

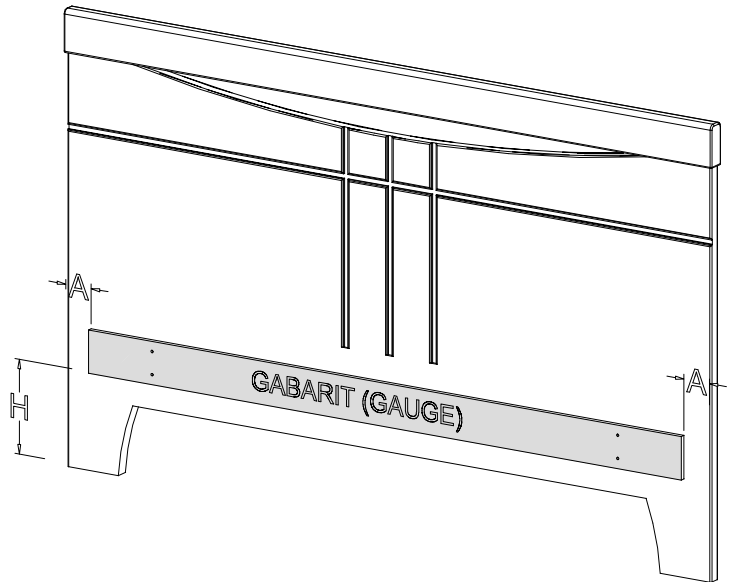

3 AVEC POINTE ET MARTEAU PREPONTE LES TROUS
MAKE HOLES WITH A NAIL AND A HAMMER

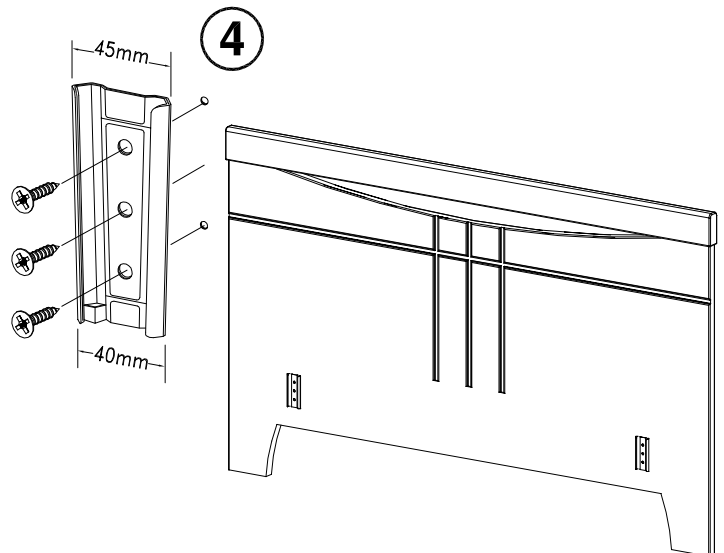

5 POSITIONNER LE GABARIT SUR LE SOMMIER
(bas du gabarit au niveau du bas du sommier)
POSITION THE GAUGE ON THE BASE
(the gauge's lower at the level of the base's lower)

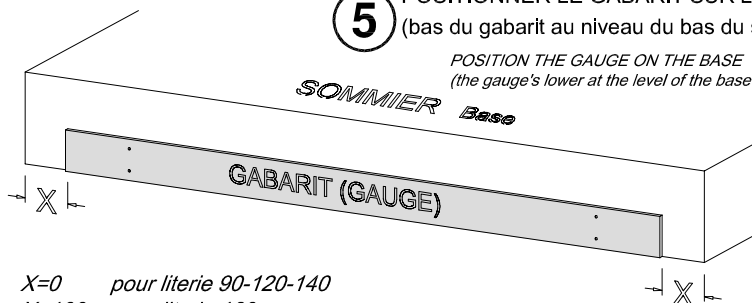

X=0 pour literie 90-120-140
X=100 pour literie 160
X=200 pour literie 180

6 AVEC POINTE ET MARTEAU PREPONTE LES TROUS
MAKE HOLES WITH A NAIL AND A HAMMER

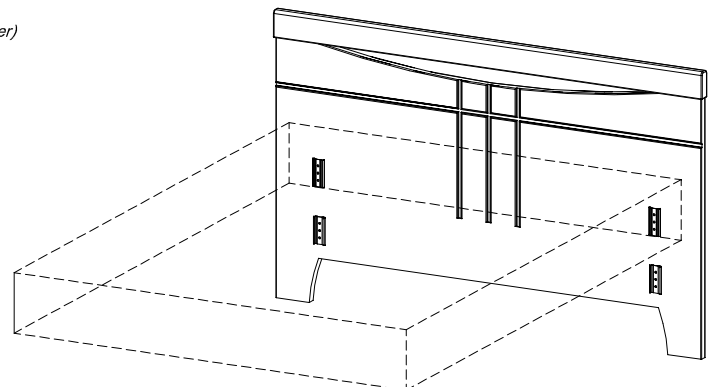
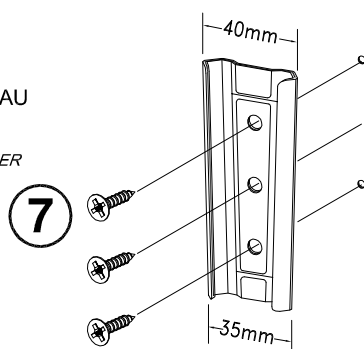

8 EMBOITER LE SOMMIER SUR LE DOSSIER
FIT TOGETHER THE BASE ON THE HEAD OF BED