

LOT DE 2 TIROIRS EN KIT – Notice de montage

Date d'édition : 2008 /// Très important : Conservez cette notice, elle vous sera indispensable en cas de réclamation.

Caractéristiques particulières : Vernis hydro /// Conseil d'entretien : Un simple passage de chiffon suffit.

CONFORME AUX EXIGENCES DE SECURITE

Attention : Ne pas changer la fabrication.

ESAT Le Hameau – 27, avenue Larribau – 64000 Pau – Tel : 05.59.80.19.33 / Fax : 05.59.80.35.75

A

PREPARATION AVANT MONTAGE

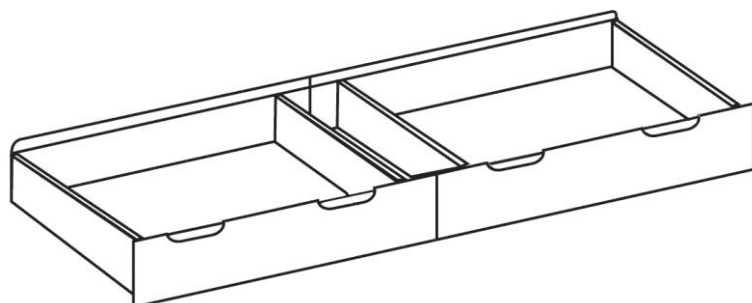

2 x

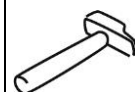

- 1) Classez par groupe les pièces de quincaillerie.
- 2) Repérez les différents panneaux.
- 3) Posez un carton ou une couverture sur le sol pour protéger les panneaux.
- 4) Procurez-vous l'outillage nécessaire.

B

TABLEAU DES QUINCAILLERIES

8 roulettes

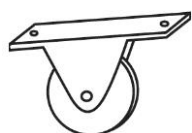

16 vis 3,5 x 16

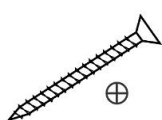

16 tourillons 8 x 30

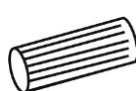

16 vis 4 x 30

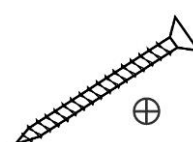

16 têtes de serrage



C

NOMENCLATURE BOIS

2 Façades F

4 Cotés C

2 Panneaux fond P

2 Arrières A

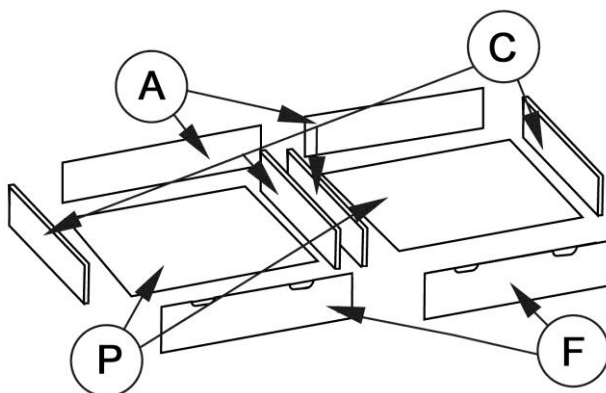

D

MONTAGE

