

LIT TIROIR EN KIT – Notice de montage

Date d'édition : 2008 /// **Très important :** Conservez cette notice, elle vous sera indispensable en cas de réclamation.
Caractéristiques particulières : Vernis cellulosique /// **Conseil d'entretien :** Un simple passage de chiffon suffit.

CONFORME AUX EXIGENCES DE SECURITE

Attention : Ne pas changer la fabrication.

ESAT Le Hameau – 27, avenue Larribau – 64000 Pau – Tel : 05.59.80.19.33 / Fax : 05.59.80.35.75

A PREPARATION AVANT MONTAGE

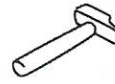
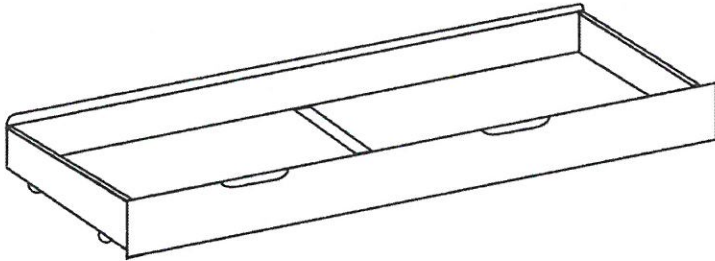

- 1) Classez par groupe les pièces de quincaillerie.
- 2) Repérez les différents panneaux.
- 3) Posez un carton ou une couverture sur le sol pour protéger les panneaux.
- 4) Procurez-vous l'outillage nécessaire.

B TABLEAU DES QUINCAILLERIES

6 roulettes

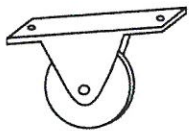

12 vis 3,5 x 16

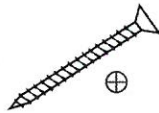

8 tourillons 8 x 30

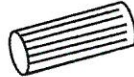

10 vis 4 x 30

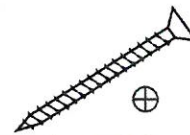

10 têtes de serrage



C NOMENCLATURE BOIS

- 1 façade **F**
- 2 côtés **C**
- 1 traverse **T**
- 2 panneaux fond **P**
- 1 arrière **A**

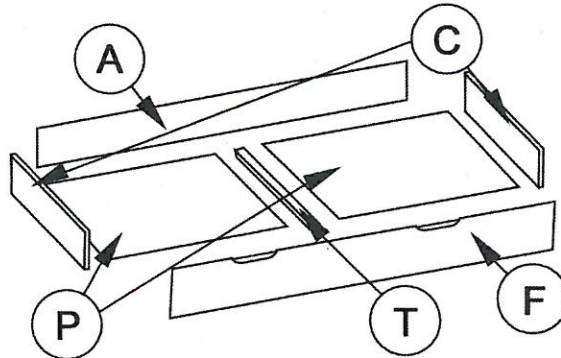

D MONTAGE

